

Fluxgate Closed Loop Current Sensor CYFGCS600HIT-40mA

CYFGCS600HIT-40mA is a current sensor based on the fluxgate closed-loop principle, and can be used for measuring DC, AC, pulse and various irregular waveform currents under galvanic isolation conditions.

The multi-point zero-flux technology is applied to existing high-precision DC sensor technology. By combining excitation flux closed-loop control, self-excitation flux gate technology, and multi-loop control, it achieves zero-flux closed-loop control of excitation flux, DC flux, and AC flux. Additionally, by establishing a high-frequency ripple sensing channel, it enables the detection of high-frequency ripple, thereby providing the sensor with high gain and measuring accuracy across the entire bandwidth.

Core Technologies

- Closed-loop excitation flux control technology
- Self-excitation demagnetization technology
- Multi-point zero-flux technology
- Multi-range automatic switching technology
- Temperature compensation technology

Performance Features

- Primary-to-secondary isolation measurement
- Excellent linearity and accuracy
- Extremely low temperature drift
- Extremely low zero drift
- Strong resistance to electromagnetic interference
- Wide bandwidth and fast response time

Technical Data

Parameters	Symbol	Test Conditions	Values	Unit
Supply Voltage	V_C		$\pm 15(\pm 5\%)$	V
Rated input current DC	I_{PN_DC}		± 600	A
Rated input current AC RMS	I_{PN_AC}		420	A
Overload Current	I_{PM}	1 min	$1.2 \times I_{PN}$	A
Current to current ratio	K_N	Input : Output	600 : 40	A/mA
Rated output current DC	I_{OUT}	Rated input current	± 40	mA
Measuring resistance	R_M		0 ~ 250	Ω
Current consumption	I_C	Rated input current	$\pm 50 \sim \pm 390 \sim \pm 430$	mA
Linearity	ϵ_L	Whole measuring range	<0.002	%
Accuracy ($T_A = -40^\circ\text{C} \sim 85^\circ\text{C}$)	X	DC input current	<0.02	%
Zero point offset current	I_O	$T_A = 25^\circ\text{C}$	< ± 5	μA
Thermal drift of offset current	I_{OT}	$T_A = -40^\circ\text{C} \sim 85^\circ\text{C}$	< ± 10	μA
Following accuracy di/dt	di/dt		>100	A/ μs
Response time	T_r	di/dt=100A/ μs , 90% I_{PN}	<1	μs
Bandwidth (-3dB)	F		DC~100	kHz
Operating temperature	T_A		-40~+85	$^\circ\text{C}$
Storage temperature	T_S		-55~+95	$^\circ\text{C}$
Relative humidity	RH		20-80	%
Mass	m		420 \pm 50	g

Safety Features

Parameters	Symbol	Test Conditions	Values	Unit
Isolation voltage	V_d	50Hz, 1min	5	kV
Transient isolation voltage	V_w	50 μs	10	kV
Creepage distance	dCp	Primary side to enclosure	20	mm
Electrical Clearance	dCi	Primary side to enclosure	20	mm
Comparative tracking index	CTI	IEC-60112	275	V

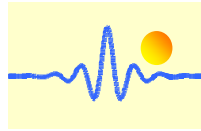

Case Style and Connection

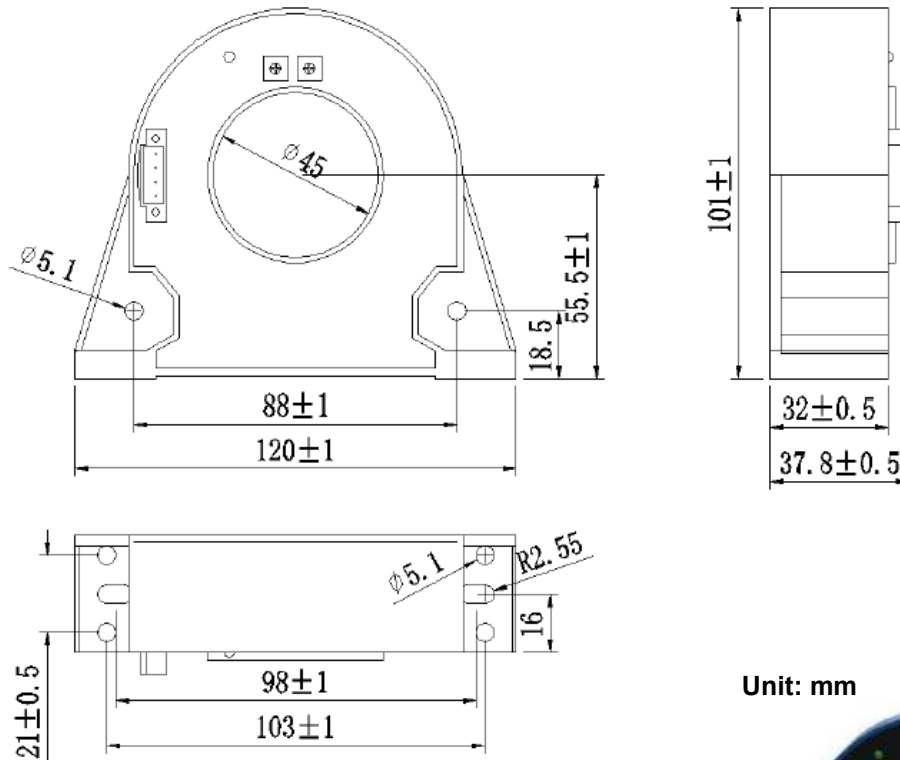

Unit: mm

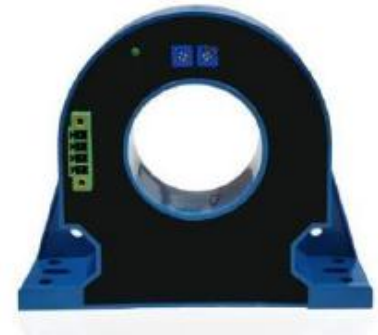

Pin arrangement:

V+: +15V
V-: -15V
OUT: I_{OUT}
GND: 0V (power ground)

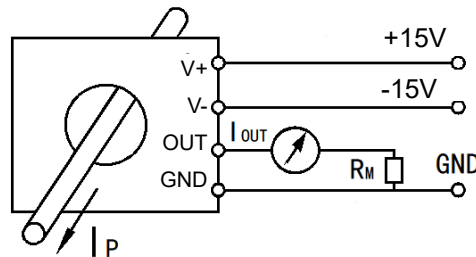

This product is an injection-moulded part made of ABS+PC. Unless otherwise specified, its dimensions and mounting dimensions comply with GB/T 14486-2008 MT6.

Operating Status Description

◇ During normal operation, the green light remains on:

After the device is powered on, the green indicator light remains on when the device is functioning normally.

◇ The green light turns off in case of current overload or power supply abnormalities:

If the green light is off, first check whether the sensor's power supply is functioning normally.

If the power supply is normal but the green indicator light is off, this indicates that the current sensor is in a non-zero flux state. If the bus input current exceeds the sensor's specified range at this point, the sensor enters overload mode, and the output current is no longer proportional to the input current signal. In overload mode, the sensor's output current remains at its maximum level, and the green indicator light turns off. Once

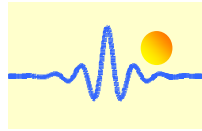

the input current returns to the specified measuring range, the sensor's output current returns to normal, and the green indicator light remains lit.

Test Instructions

By measuring the output current I_{OUT} flowing through the R_M , or the voltage U_R across the measuring resistor R_M , the primary current I_P can be determined by:

$$I_P = K_N * I_{OUT} = K_N * (U_R / R_M)$$

Application Note

1. Incorrect wiring may cause damage to the sensor. After the sensor is powered on, the same-phase voltage value can be measured at the output terminal when the measured current passes through the sensor in the direction of the arrow.
2. When taking measurements with the sensor, configure the measuring resistor according to the specifications in the data sheet. Additionally, ensure that the measuring resistor is securely connected to the sensor's output terminal to prevent an open circuit in the sensor output, which could cause product malfunction.
3. The sensor must be powered with two voltage supplies. The operating voltage of the power supplies must comply with the requirements, and the supply current for both the positive and negative terminals must be no less than the maximum power consumption current specified in this data sheet, with a margin of safety.
4. The temperature of the primary measuring wire or copper rod should not exceed 95°C.

Application Areas

- Medical Equipment: Scanners, MRI
- Power: Converters, Inverters
- New Energy: Photovoltaics, Wind Power
- Automotive: Electric Vehicles
- Naval: Electric-powered Ships
- Aerospace: Satellites, Rockets
- Metrology: Verification and Calibration
- Rail Transit: High-speed Trains, Subways, Trams and Trolleys
- Test and measuring instruments: Power analyzers, high-precision power supplies
- Smart grid measurement: Power generation, battery monitoring, medium- and low-voltage substations
- Industrial control: Industrial motor drives, welding, robotics, cranes, elevators, ski lifts