

Open Loop Hall AC/DC Current Sensor CYHCS-K200

This Hall Effect current sensor is based on open loop principle and designed with a high galvanic isolation between primary conductor and secondary circuit. It can be used for measurement of DC and AC current, pulse currents etc. The output of the transducer reflects the real wave of the current carrying conductor.

Product Characteristics	Applications
<ul style="list-style-type: none"> • Excellent accuracy • Very good linearity • Small size and encapsulated • Less power consumption • Current overload capability 	<ul style="list-style-type: none"> • Photovoltaic equipment • General Purpose Inverters • AC/DC Variable Speed Drivers • Battery Supplied Applications • Uninterruptible Power Supplies (UPS) • Switched Mode Power Supplies

ELECTRICAL CHARACTERISTIC

Part number	CYHCS-K200-10A	CYHCS-K200-20A	CYHCS-K200-30A	CYHCS-K200-50A
Nominal current	10A	20A	30A	50A
Measuring range	0 ~ 20A	0 ~ 40A	0 ~ 60A	0 ~ 100A
Nominal analogue output voltage	+2.5VDC \pm (1V \pm 1.0%)			
Supply voltage	+5V \pm 5%			
Galvanic isolation	50Hz, 1min, 2.5kV			

ACCURACY DYNAMIC PERFORMANCE

Zero offset voltage at +25°C	2.5 \pm 0.5%	V
Magnetic offset voltage	25	mV
Thermal drift of offset voltage	$\leq \pm 0.5$	mV/°C
Measuring accuracy	≤ 1.0	% FS
Linearity	≤ 1.0	%FS
Response time	<3	μ S
Bandwidth (-1db)	DC ~ 200	kHz
Load resistance	≥ 10	k Ω

GENERAL CHARACTERISTIC

Operating temperature	-25 ~ +85	°C
Storage temperature	-40 ~ +100	°C
Current consumption	20	mA

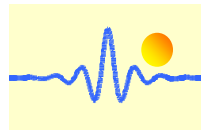

Relation between Input Current and Output Voltage

Take the sensor CYHCS-K200-30A as sample, the relation between the input current and output voltage is shown in the table 1, Fig.1 and Fig. 2

Table 1. Relation between the input current and output voltage

Input current (A)	-60	-45	-30	-15	0	15	30	45	60
Output voltage (V)	0.5	1.0	1.5	2.0	2.5	3.0	3.5	4.0	4.5

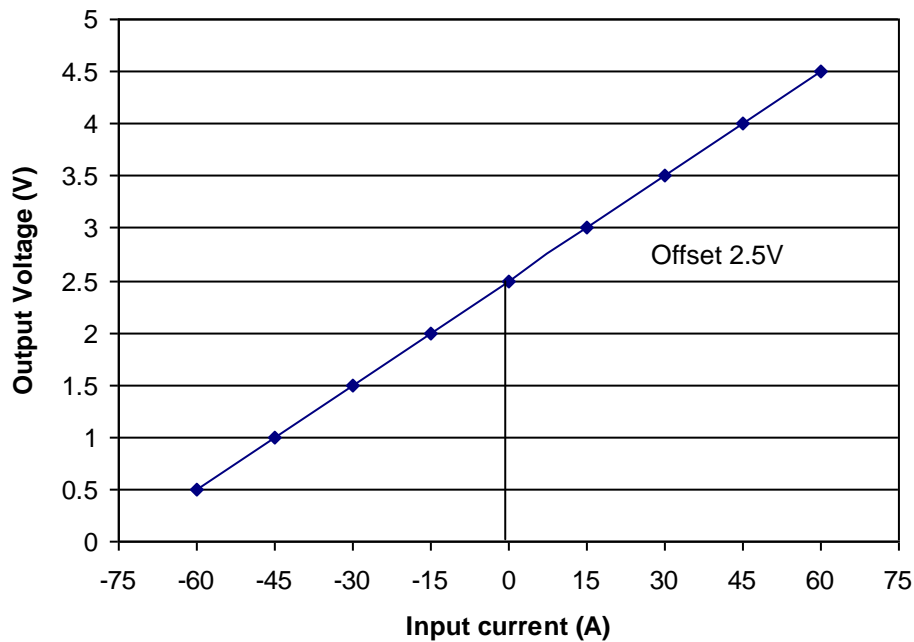

Fig. 1 Relation between the input current (DC) and output voltage (DC)

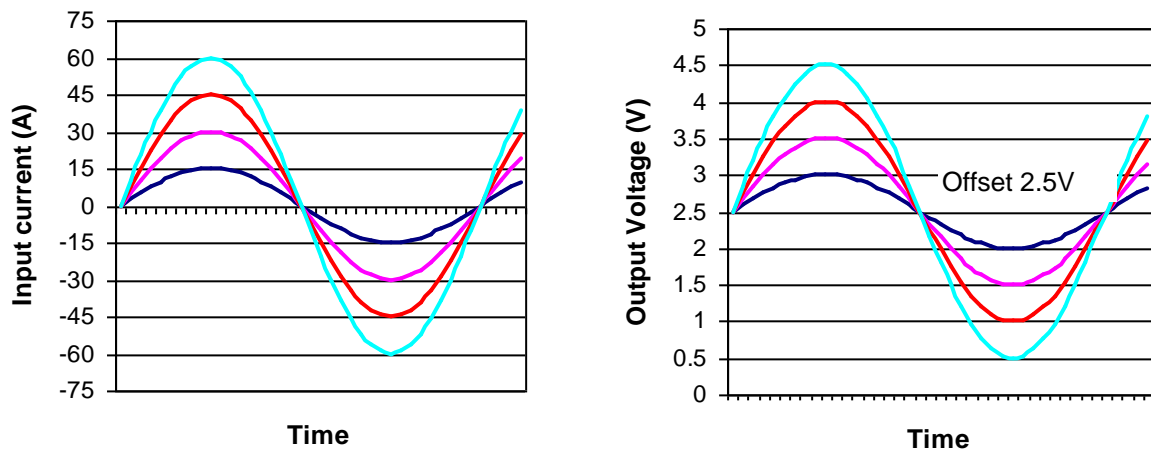
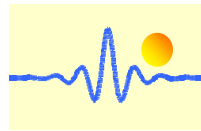

Fig. 2 Relation between the input current (AC) and output voltage (AC)



Dimensions (mm)

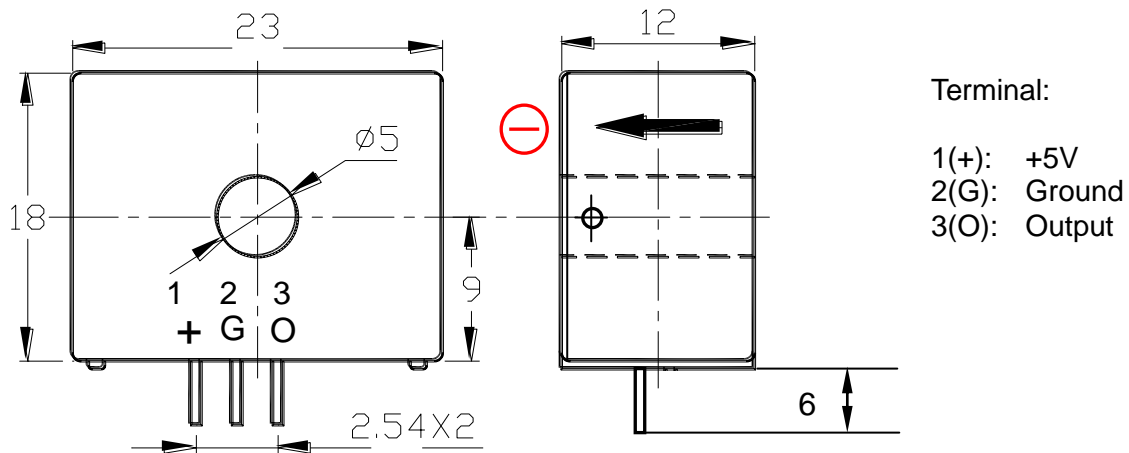

Fig. 3 Dimensions of CYHCS-K200

Connection

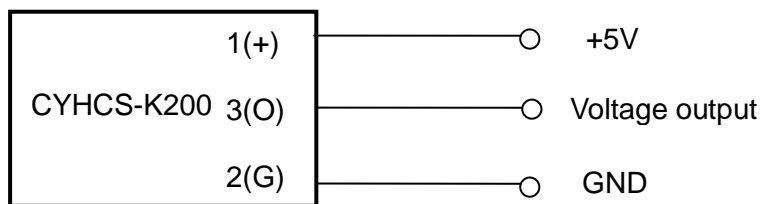
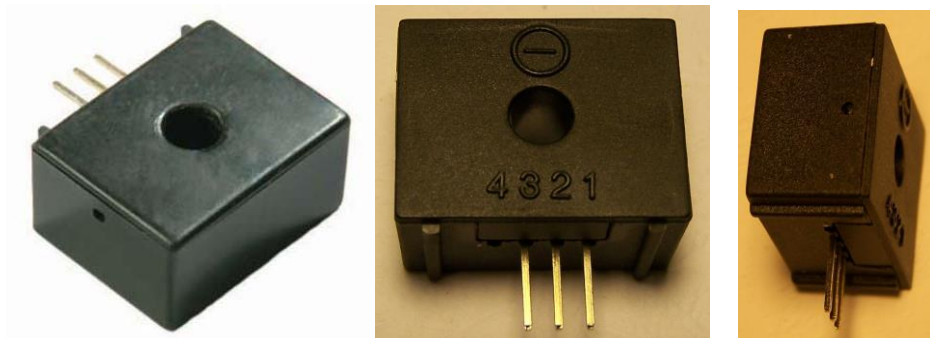

Fig. 4 Connection of CYHCS-K200



Notes:

1. Connect the terminals of power source, output respectively and correctly, never make wrong connection.
2. The in-phase output can be obtained when the current direction of current carrying conductor is the same as the direction of arrow marked above.
3. The best accuracy can be achieved when the window is fully filled with cable (current carrying conductor).